

SERVICE DOORS

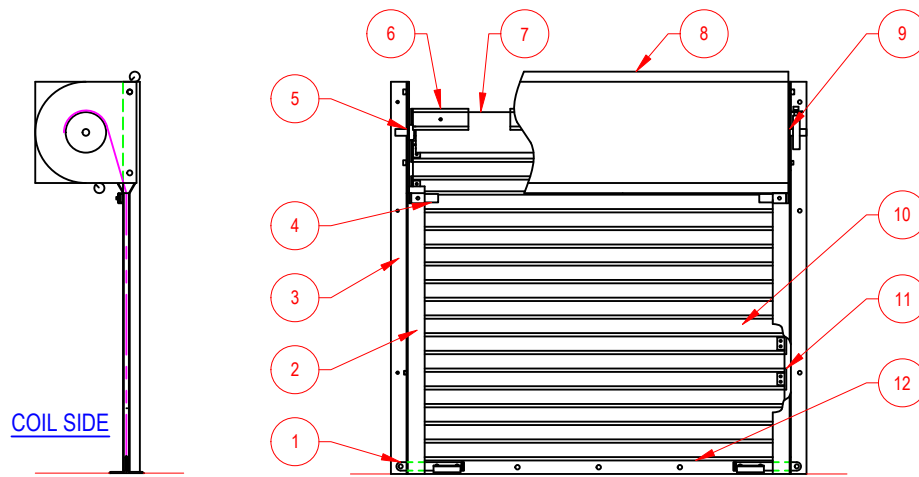

NO.	DESCRIPTION
1	SLIDE LOCK
2	GUIDE
3	WALL ANGLE
4	CURTAIN STOP
5	DRIVE BRACKET
6	STARTER SLAT
7	BARREL
8	HOOD
9	TENSION BRACKET
10	SLAT CURTAIN
11	ENDLOCK
12	BOTTOM BAR

COUNTER SERVICE DOORS

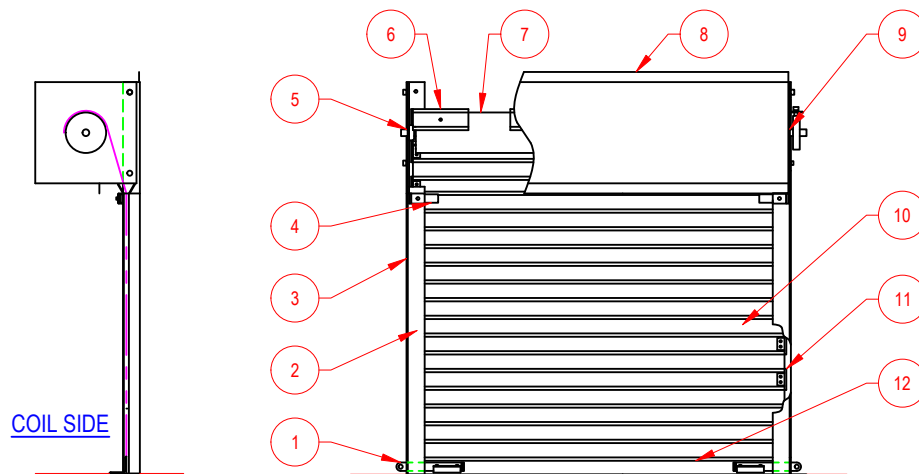

NO.	DESCRIPTION
1	SLIDE LOCK
2	GUIDE
3	WALL ANGLE
4	CURTAIN STOP
5	DRIVE BRACKET
6	STARTER SLAT
7	BARREL
8	HOOD
9	TENSION BRACKET
10	SLAT CURTAIN
11	ENDLOCK
12	BOTTOM BAR

GRILLES

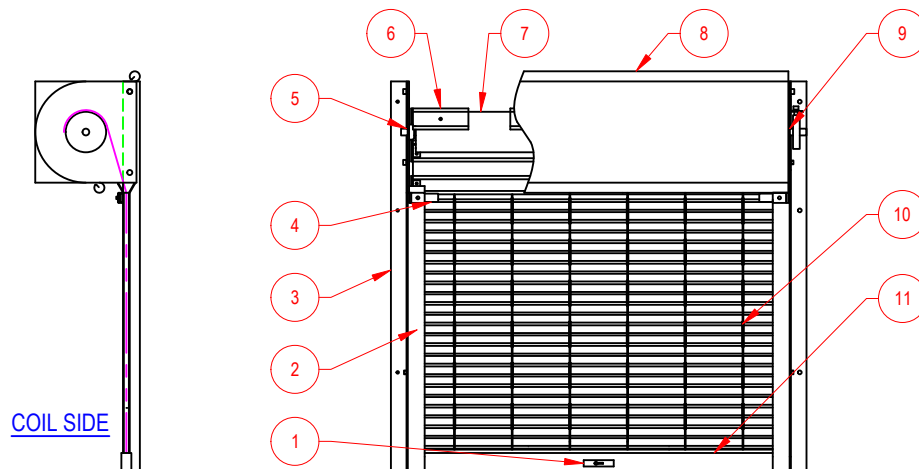

NO.	DESCRIPTION
1	CYLINDER LOCK
2	GUIDE
3	WALL ANGLE
4	CURTAIN STOP
5	DRIVE BRACKET
6	STARTER SLAT
7	BARREL
8	HOOD
9	TENSION BRACKET
10	GRILLE CURTAIN
11	BOTTOM BAR

SLAT TYPES

FOR MODELS:

SD, MD, HD, CD
MW, HW

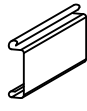

Type 'F' Flat Slat
2" x 9/16"

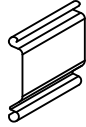

Type 'C' Curved Slat
3 1/4" x 9/16"

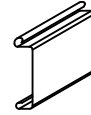

Type 'T' Flat Slat
2 5/8" x 3/4"

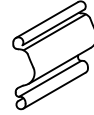

Type 'A' Curved Slat
2 5/8" x 7/8"

FOR MODELS:

MI, HI

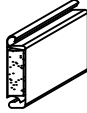

Type 'Ti' Insulated Slat
(PVC Back)
2 5/8" x 13/16"

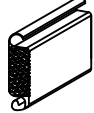

Type '3i' Insulated Slat
(Metal Back)
2 1/2" x 13/16"

FOR MODELS:

HV

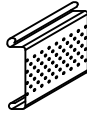

Type 'T' Flat Slat

GRILLE PATTERNS

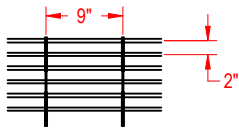

SL-9 Curtain
Single 1/8" & Double 1/16" 3-Hole Links
Links 9" OC - Rods 2" OC

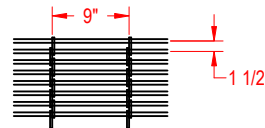

HL-9 Curtain
3/16" 2-Hole Links
Links 9" OC - Rods 1 1/2" OC

BOTTOM BARS

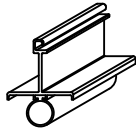

Aluminum Bottom Bar

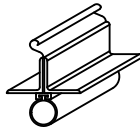

Double Angle Bottom Bar

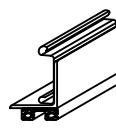

Single Angle Bottom Bar

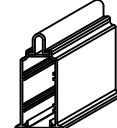

Tubular Bottom Bar

GUIDES

FOR MODELS:

SD, MD, HD, MW, HW,
MI, HI, HV

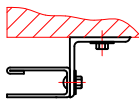

Type 'Z' Guide
(Shown with Windlock Retainer)

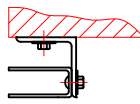

Type 'E' Guide

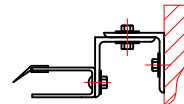

Between Jamb Guide
(Shown with guide weatherstrip)

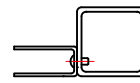

Tube Mount Guide

FOR MODELS:

CD, CG

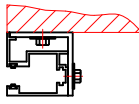

Face Mount

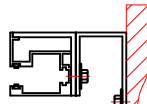

Between Jamb Mount

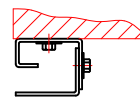

Face Mount
(Optional)

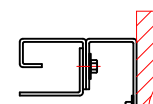

Between Jamb Mount
(Optional)

FOR MODELS:

SG, HG

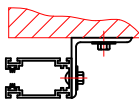

Type 'Z' Guide

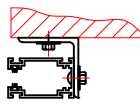

Type 'E' Guide

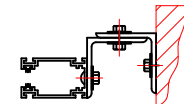

Between Jamb Guide

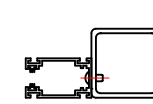

Tube Mount Guide

PUSH-UP BRACKET

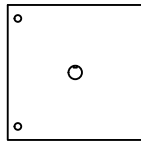

No Mechanism

AWNING CRANK BRACKET

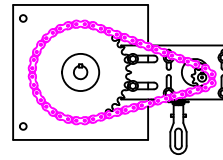

Roller Chain Reduction
(Removable Handle Not Shown)

CHAIN HOIST BRACKETS

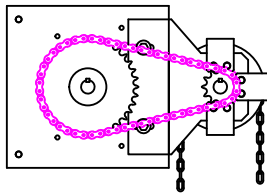

Roller Chain Reduction

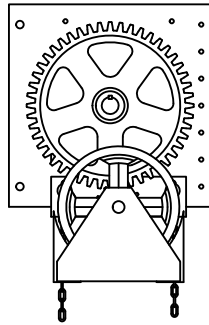

Single Gear Reduction

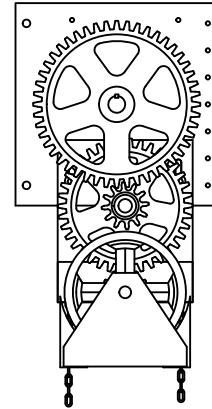

Multiple Gear Reduction

MOTOR BRACKETS

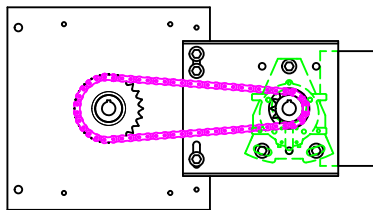

Straight Mounting Plate

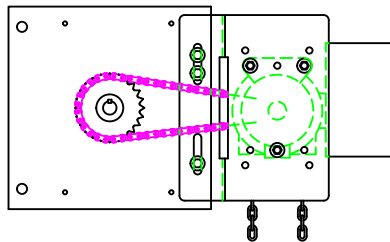

Bent Mounting Plate

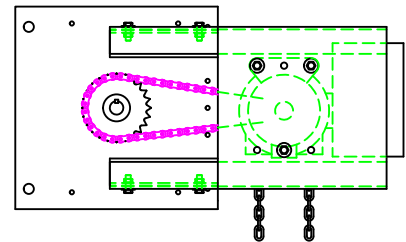

Heavy Duty Mounting Plate

TENSION BRACKETS

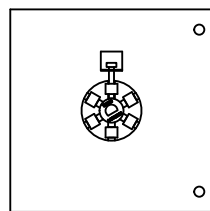

Standard Tension Bracket

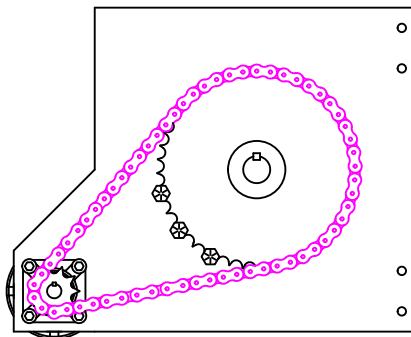

Compound Tension Bracket