







**SPECIFICATIONS**

FM Approved • CSFM Listing No. 3515-1587:100

<b>MAXIMUM SIZE</b>	44 ft. wide, 24 ft. high
<b>CLASSIFICATION</b>	FM Approved
<b>LABEL</b>	FM Fire Door Label to 12 ft. wide, 12 ft. high, 144 sq. ft. on masonry walls, or 12 ft. wide, 12 ft. high, 120 sq. ft. on non-masonry walls, or oversize door label on larger sizes
<b>RATING</b>	Fire rated up to 3 hours on interior or exterior walls of masonry construction, 1 1/2 hours on interior non-masonry walls
<b>CURTAIN</b>	Interlocking galvanized steel Type '33' flat slats - 22 gauge to 24 ft. wide, 20 gauge over 24 ft. wide - insulated with mineral wool and covered with fully interlocking 24 gauge backslates, with endlocks riveted to ends of alternate slats
<b>BOTTOM BAR GUIDES</b>	Two 2" x 2" x 1/8" min. steel angles
<b>BRACKET</b>	Formed 11 gauge min. steel U-channel guides on doors to 24 ft. wide (1/4" min. steel angles on wider doors) and steel wall angles bolted together and to wall with 3/8" min. fasteners no more than 24" apart
<b>BARREL BRACKETS</b>	6 5/8" min. steel pipe and solid steel shaft with sealed precision bearing and torsion spring(s) designed for 20,000 operating cycles
<b>HOOD</b>	3/16" min. steel plates with sealed precision bearing on operator side and external tension adjustment wheel
<b>OPERATION</b>	24 gauge min. galvanized steel with integral flame baffle "Easy-Reset" chain operator on doors to 20 ft. wide, 16 ft. high, 250 sq. ft., "Easy-Reset" motor operator on doors exceeding limits of chain operator <i>NOTE: "Easy-Reset" chain and motor operators have an internal release and governor with an average closing speed of 9" to 12" per second and eliminate the need for traditional mechanical reset</i>
<b>RELEASE LOCKS</b>	Fusible link activated single-side release, governor controlled descent with average closing speed between 6" and 24" per second
<b>FINISH</b>	Slide locks on coil side of bottom bar
<b>WARRANTY</b>	Baked-on primer and grey top coat on slats, backslates and hood, shop painted black primer on bottom bar, guides and brackets Two year limited warranty (excluding finish)

**COMMON OPTIONS**

-  S-label for air-leakage rated "smoke" doors
-  Fire rated up to 4 hours
-  Flame baffle
-  Auto-Reset chain, crank, motor operators
-  FirePro™ Inspectors Test switch for Auto-Reset fire doors
-  AR-D fail safe time delayed alarm release or AR-D2 alarm release with 7-day battery backup

**OTHER OPTIONS**

- Designs for up to 100,000 operating cycles
- Audible, visible and voice warning devices
- Stainless steel doors (to 36 ft. wide)
- UL-listed brush seals (included with S-label)
- Sloping or irregular shaped bottom bars
- Galvanized or powder coat finishes

**CURTAIN & BOTTOM BAR DETAILS**

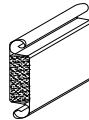

Type '33' Insulated Slat

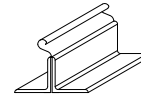

Steel Angle Bottom Bar

**GUIDE DETAILS**

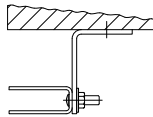

Type 'Z' Guide

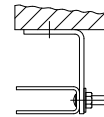

Type 'E' Guide

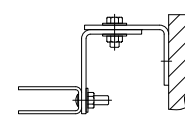

Between Jamb Guide

**CLEARANCES** (typical face mount door shown)

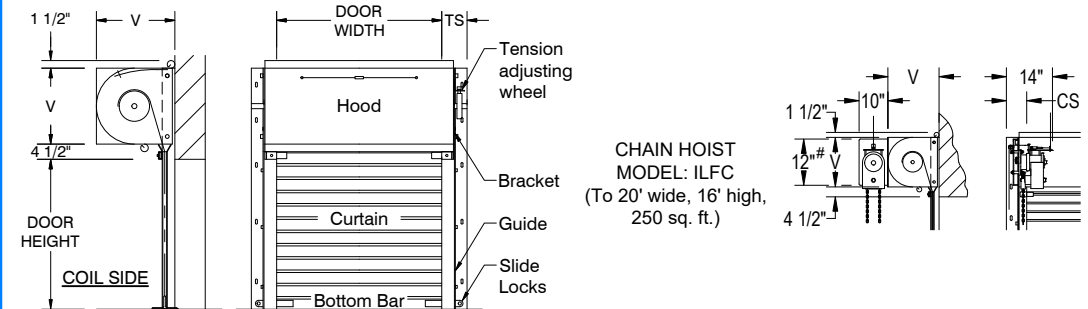

Clearances shown are for doors to 20 ft. wide, 16 ft. high  
Consult factory for clearances on larger doors

CS	MS	TS
8"	8"	8"

- 'V' for doors to 7 ft. high is 15 1/2"
- 'V' for doors over 7 ft. to 11 ft. high is 18"
- 'V' for doors over 11 ft. to 15 ft. high is 20"
- 'V' for doors over 15 ft. high is 22"
- ("V" dimension includes required expansion clearance)

**GENERAL NOTES:**

Clearances are based upon standard door construction. Reduced clearances may be available. Some options may require additional clearance. Drive side shaft may need to be field cut to fit in clearances shown. Shop drawings for specific applications are available. Consult factory for any information not shown.  
\*Available as an option # "Auto-Reset" increases height of operator by approximately 3"