

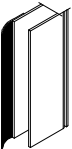

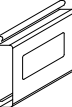

**SPECIFICATIONS**

- MAXIMUM SIZE** 30 ft. wide, 16 ft. high
- CURTAIN** Interlocking galvanized steel 20 gauge Type 'T' flat slats, perforated with 1/8" holes on 3/16" staggered centers (28% open area), with endlocks riveted to alternate slats and windlocks riveted to slats when required by 20 PSF windload design
- BOTTOM BAR GUIDES** Two 2" x 2" x 1/8" min. steel angles with vinyl weatherstrip
- BARREL** Formed 3/16" steel U-channel guides and 3/16" min. steel wall angles bolted together and to wall with 3/8" min. fasteners 24" apart
- BRACKETS** 6 5/8" min. steel pipe and solid steel shaft with sealed precision bearing and torsion spring(s) designed for 50,000 operating cycles
- HOOD** 3/16" min. steel plates with sealed precision bearing on operator side and external tension adjustment wheel
- OPERATION** 24 gauge min. galvanized steel
- LOCKS** Push-up to 8 ft. wide and 8 ft. high, chain hoist with cast iron reduction gears on larger sizes
- FINISH** Slide locks on coil side of bottom bar
- WARRANTY** Baked-on primer and top coat on slats and hood - tan opposite coil side/off-white coil side, or grey both sides - shop painted black primer on bottom bar, guides and brackets
- WARRANTY** Two year limited warranty (excluding finish)

**COMMON OPTIONS**

-  Vinyl/brush guide weatherstrip
-  Fenestrated slats (in lieu of perforated)
-  Vinyl hood weather baffle
-  High security guide mounted lock
-  Pedestrian pass door

**OTHER OPTIONS**

- Designs for up to 100,000 operating cycles
- Tubular bottom bar with cylinder locks
- Sloping or irregular shaped bottom bars
- Galvanized or powder coat finishes

**CURTAIN & BOTTOM BAR DETAILS**

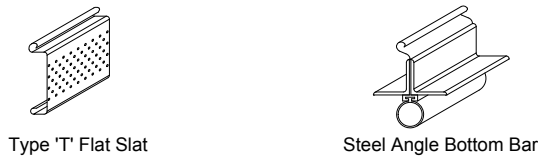

**GUIDE DETAILS**

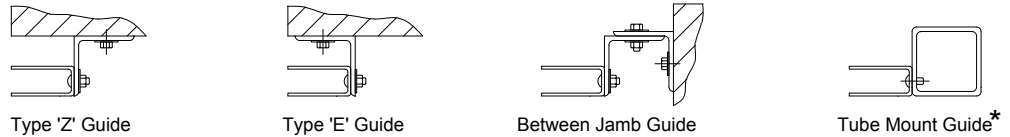

**CLEARANCES (typical face mount door shown)**

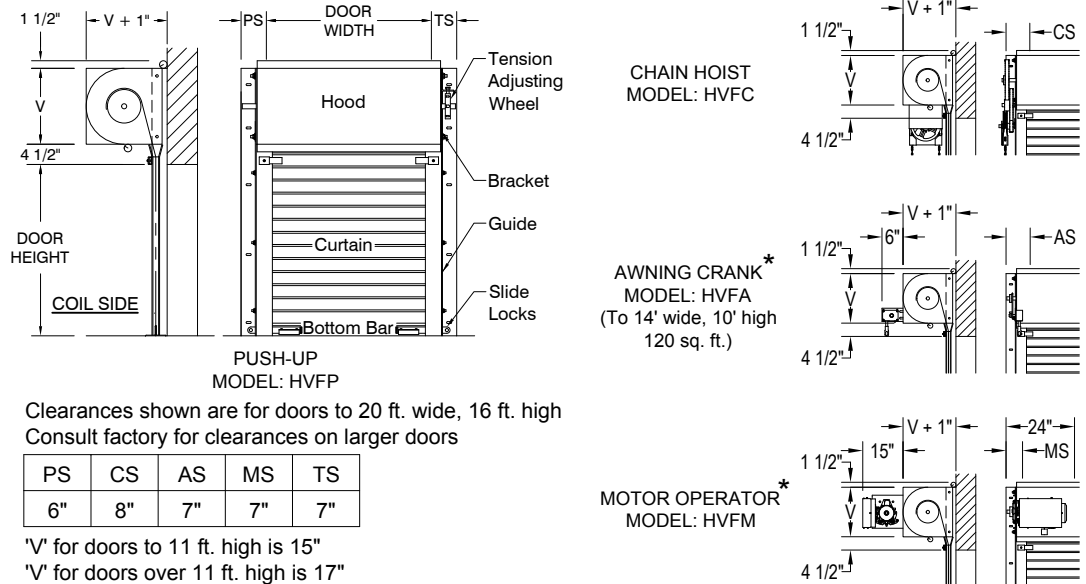

**GENERAL NOTES:**

Clearances are based upon standard door construction. Reduced clearances may be available. Some options may require additional clearance. Shop drawings for specific applications are available. Consult factory for any information not shown.

\* Available as an option