

F SERIES

SIDE FOLDING CLOSURES

The F Series Side Folding Closures offer a compact and effective security solution for minimal headroom applications such as kiosks, parcel shipping stores, and mall storefronts.

FEATURES INCLUDE:

- Multiple curtain types available (Grille, Open, Solid, and Clear Polycarbonate Panels)
- Minimal headroom clearance (Up to 2")
- Multiple curves available for flexibility (30°, 45°, and 90° with 14" radius)
- Fits into pocket storage spaces when not in use.

COMMON APPLICATIONS:

- Retail
- UPS/FedEx Stores
- Banks
- Mall Storefronts



LAWRENCE
DOORS

MADE IN THE USA
SINCE 1925

SPECIFICATIONS

MAXIMUM SIZE CURTAIN	30 ft. wide, 12 ft. high (consult factory for larger sizes) Folding 6 1/2" wide extruded aluminum panels interconnected with integral continuous vertical hinges
	Model FO - panels divided by vertical aluminum rods and horizontal stiffeners in a 2 5/16" wide, 12" high open pattern
	Model FC - panels with clear polycarbonate glazing inserts to provide a closed panel with visibility
	Model FS - panels fabricated from solid aluminum
	Model FG - horizontal links interconnected with vertical rods in a 3" wide, 12" high pattern
POSTS LOCKS	Rectangular aluminum extrusion connected to lead and rear panels and intermediately every 10 ft. (and corners as required)
TOP TRACK ROLLERS	Cylinder activated hook lock in lead post with full height wall strike; cylinder activated bottom throw-bolt lock in receiver and intermediate posts (when provided) with floor strike; self-locking trailing edge on rear post engages floor & ceiling stop
FINISH	Extruded aluminum, 1 3/4" x 1 5/8" x 1/8" thick with steel connection plate/pins at each splice
WARRANTY	Non-metallic 1 1/8" double-wheeled ball bearing rollers Mill finish (FG), clear anodized (FO, FC, FS) aluminum curtain, posts and top track One year limited warranty (excluding finish)

ALTERNATE MODELS

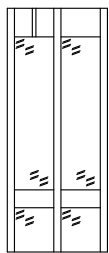

MODEL FC
CLEAR PANEL

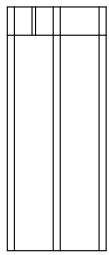

MODEL FS
SOLID PANEL

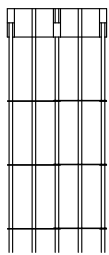

MODEL FG
ROD & LINK

COMMON OPTIONS

- Clear or bronze anodized finish
- Special cylinders
- Curved tracks
Single or compound curves
90°, 45°, 30° or custom radius

CLOSURE DETAILS

MODEL FO - OPEN PANEL SHOWN

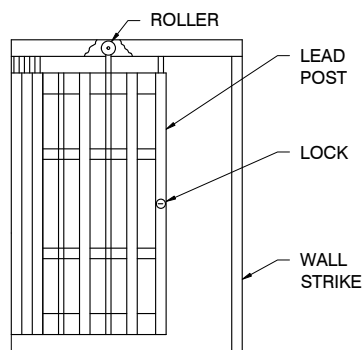

SINGLE

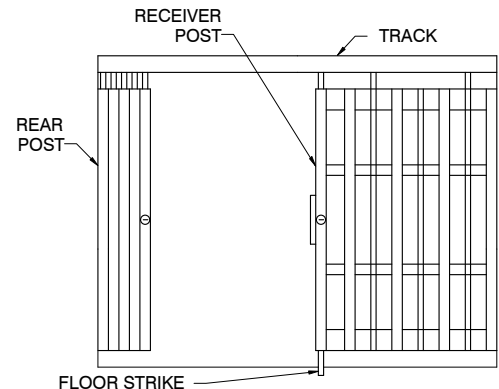

BI-PARTING

MOUNTING DETAILS

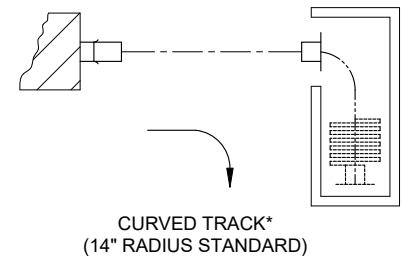
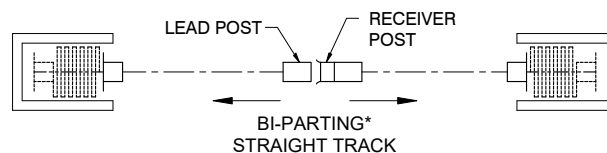
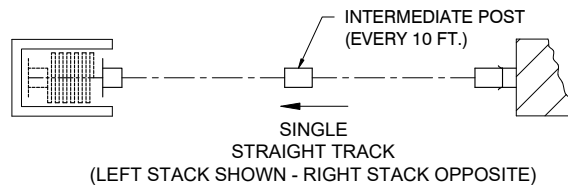

CLEARANCES:

Allow approximately 2" per ft. of width for stacking clearance.

*AVAILABLE AS AN OPTION

TRACK DETAIL

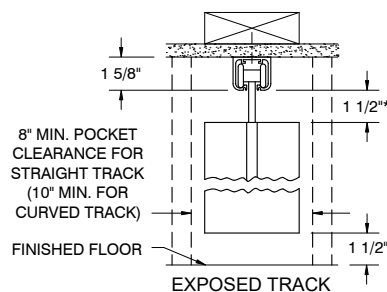

*Hold dimension for recessed track

LOCKING POSTS



Lead Post
Hook Lock



Intermediate Post
Bottom Lock

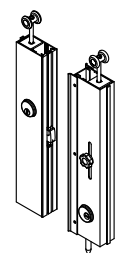

Bi-Parting Post
Hook Lock & Bottom Lock