

FOLLOWING ARE ILLUSTRATIONS OF TYPICAL PRODUCT CONFIGURATIONS - ACTUAL CONSTRUCTION MAY VARY

FIRE DOORS

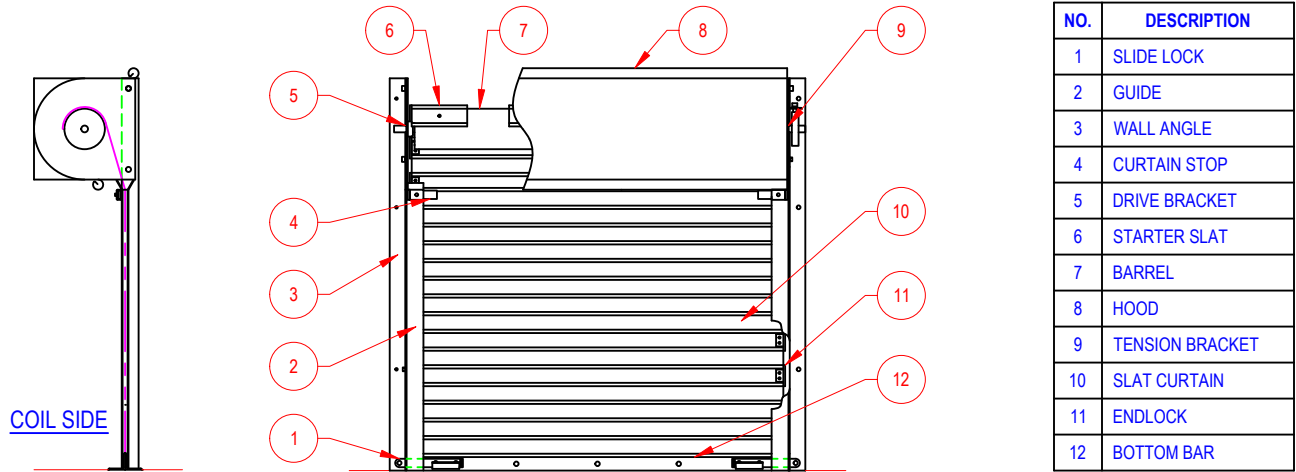

COUNTER FIRE DOORS

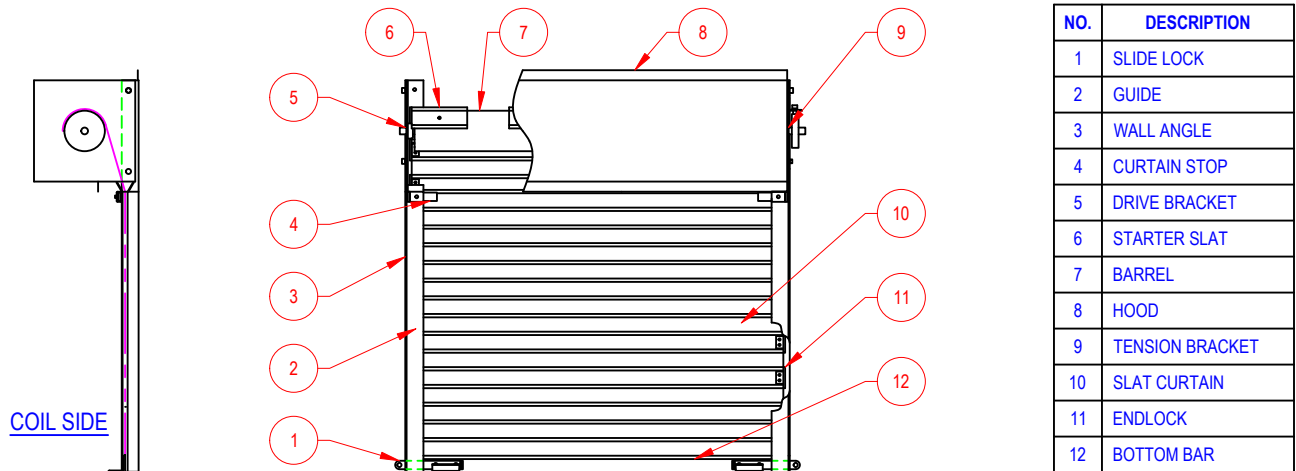

SLAT TYPES

FOR MODELS:
SL

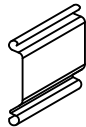

Type 'C' Curved Slat
3 1/4" x 9/16"

FOR MODELS:
ML, CL

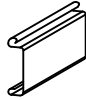

Type 'F' Flat Slat
2" x 9/16"

FOR MODELS:
HL

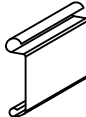

Type '3' Flat Slat
2 1/2" x 3/4"

FOR MODELS:
IL

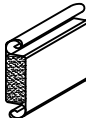

Type '33' Insulated Slat
2 1/2" x 7/8"

BOTTOM BARS

FOR MODELS:
SL, ML, HL, IL

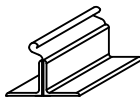

Double Angle Bottom Bar

FOR MODELS:
CL

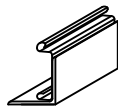

Single Angle Bottom Bar

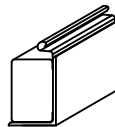

Tubular Bottom Bar
(Optional)

GUIDES

FOR MODELS:
SL, ML, HL, IL

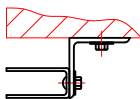

Type 'Z' Guide

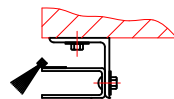

Type 'E' Guide
(Shown With Brush Seal)

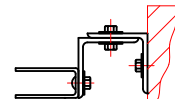

Between Jamb Guide

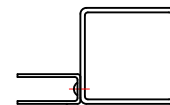

Tube Mount
(Optional)

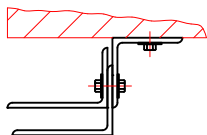

3pc. Angle Guide
(Doors Over 24' Wide,
Z-Guide Shown, Other Types Similar)

FOR MODELS:
CL

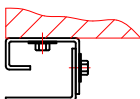

Face Mount

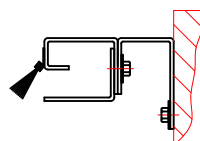

Between Jamb Mount
(Shown With Brush Seal)

PUSH-UP BRACKETS

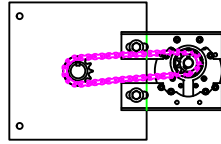

DSG Governor
(Chain cover not shown for clarity)

CHAIN HOIST BRACKETS

AWNING CRANK BRACKETS

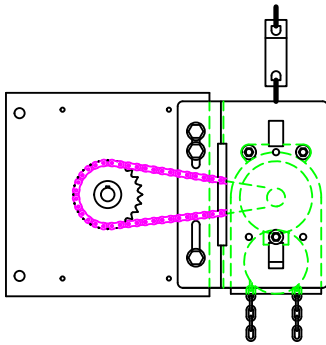

Type FHC

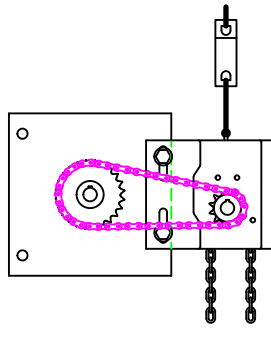

Type FHCM

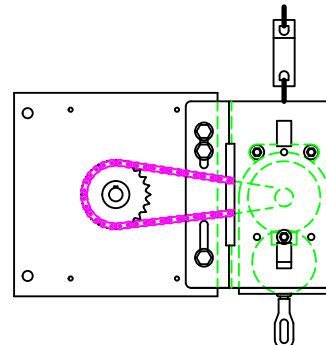

Type FHK

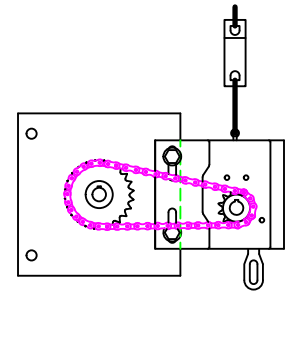

Type FHKM

MOTOR BRACKETS

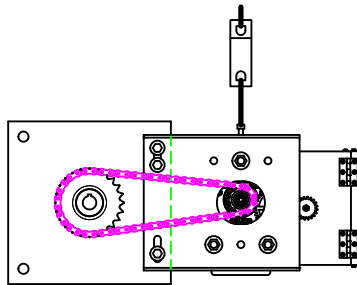

Straight Mounting Plate

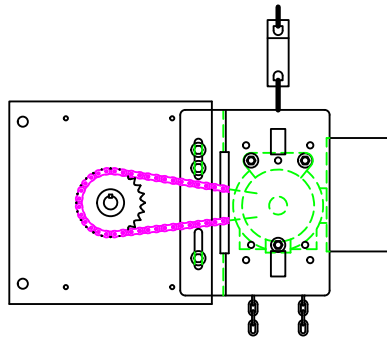

Bent Mounting Plate

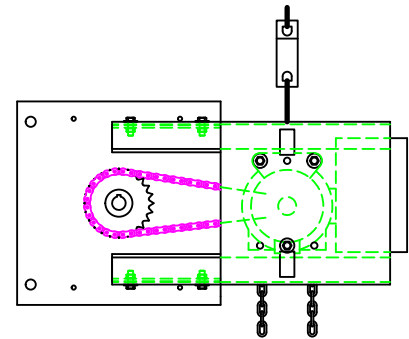

Heavy Duty Mounting Plate

TENSION BRACKETS

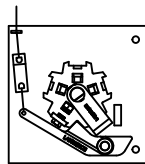

Push-Up Tension Bracket

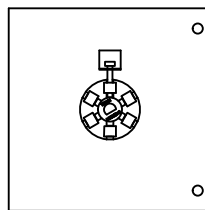

Standard Tension Bracket

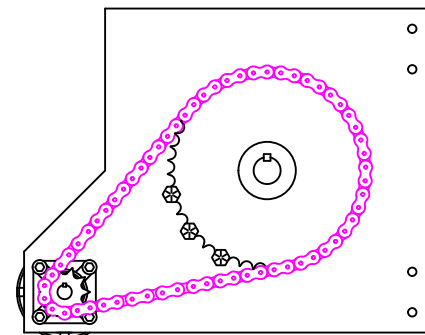

Compound Tension Bracket