

Quick Start (FS-EP) - 1 Phase

Warning: Disconnect Power Before Wiring.

QST-FS-EP-01-V03

Quick Start (FS-EP) - 1 Phase

Quick Start (FS-EP) - 1 Phase

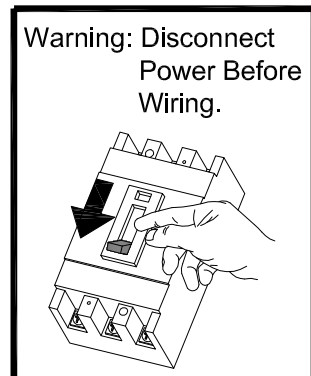
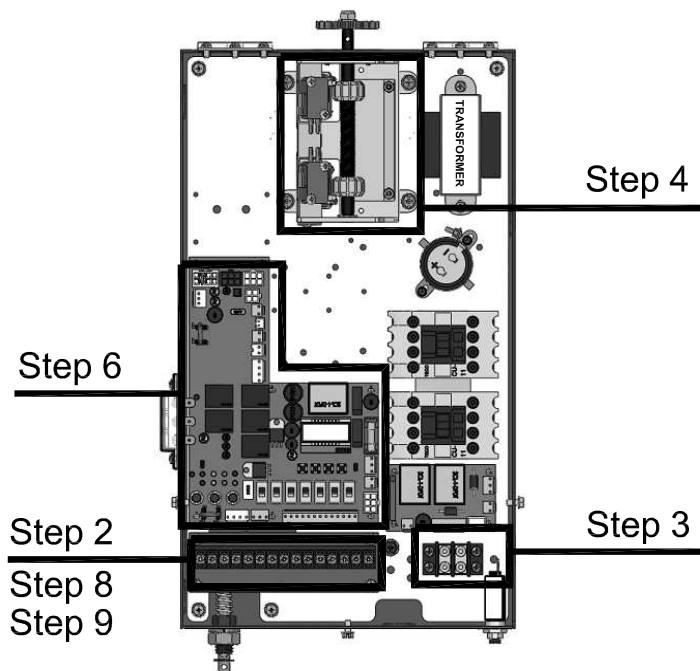

Step 1: Power OFF

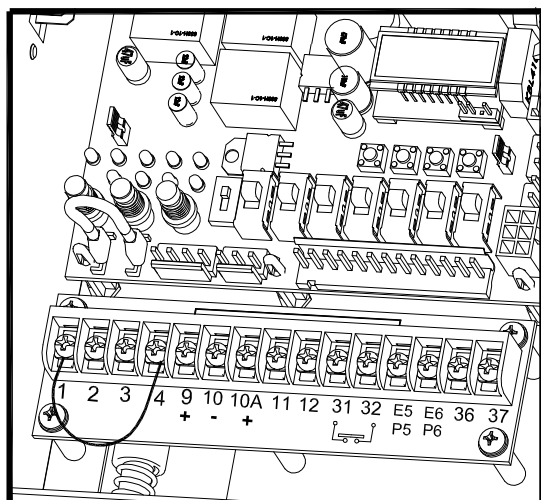

Step 2: Connect Wire 1 and 4 On CN2

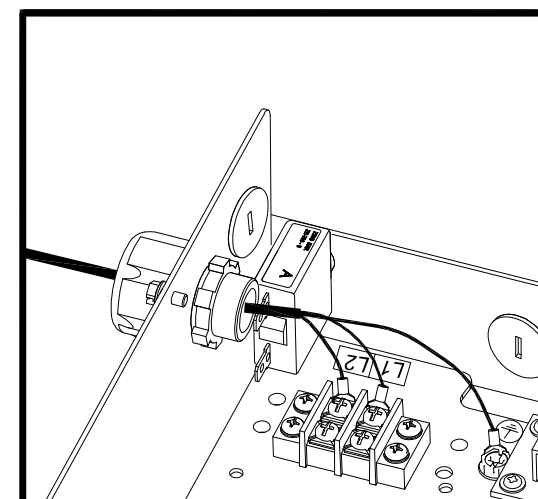

Step 3: Connect Line In

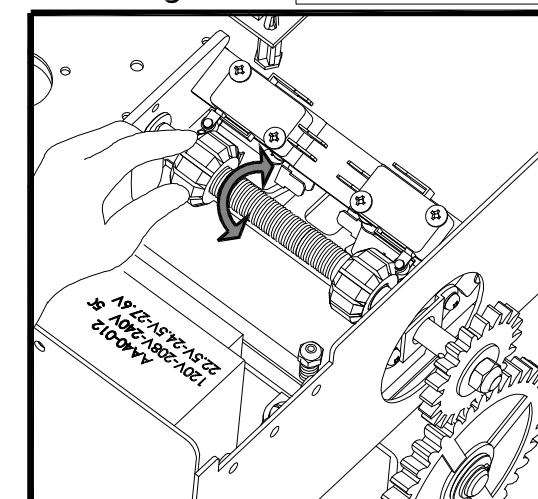

Step 4: Set Limits by Manually Running the Door. See installation instructions

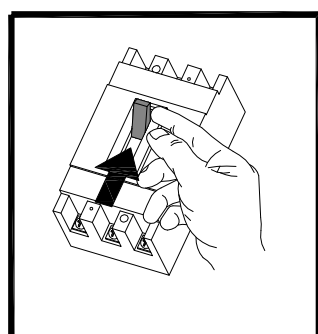

Step 5: Power ON

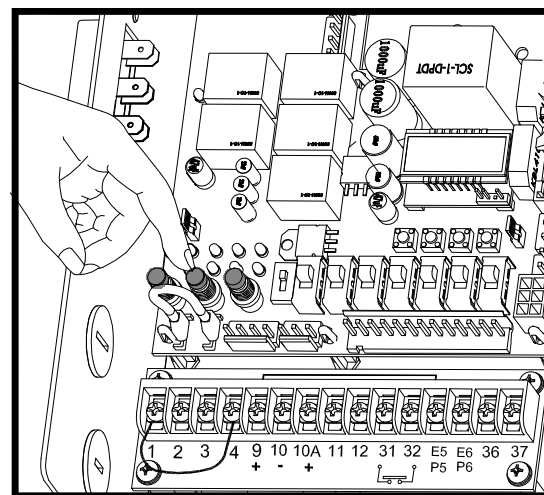

Step 6: Test Open, Close, Stop and Limits (Constant Pressure)

Note:
Door and Operator Must Function Properly Without External Connections. Please call factory if you have problems.

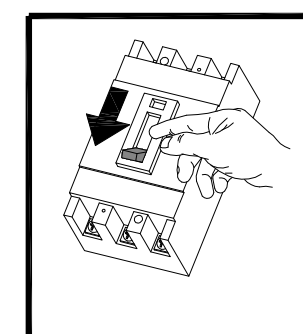

Step 7: Power OFF

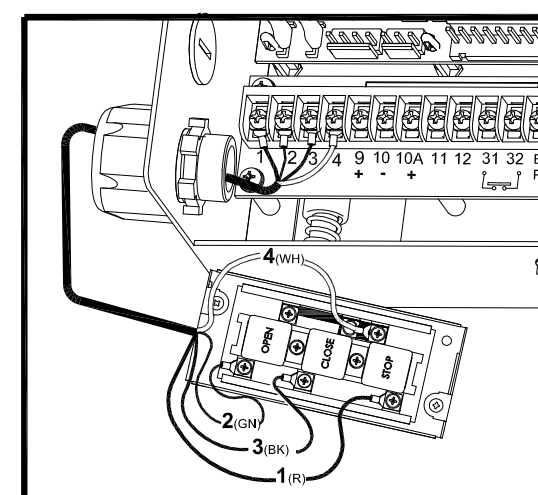

Step 8: Remove 1 and 4 Jumper, Connect 3-Button Station

Quick Start (FS-EP) - 1 Phase

Quick Start (FS-EP) - 1 Phase

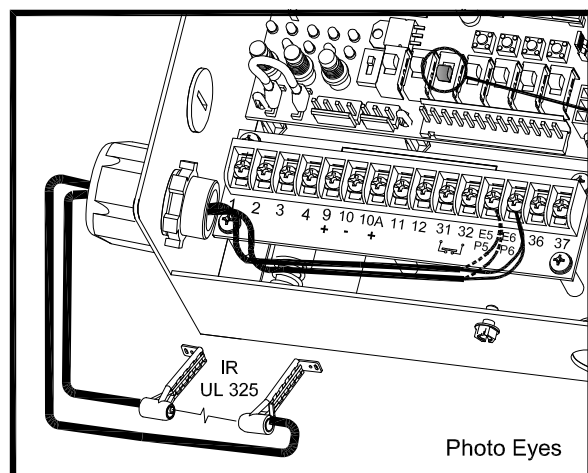
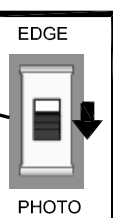
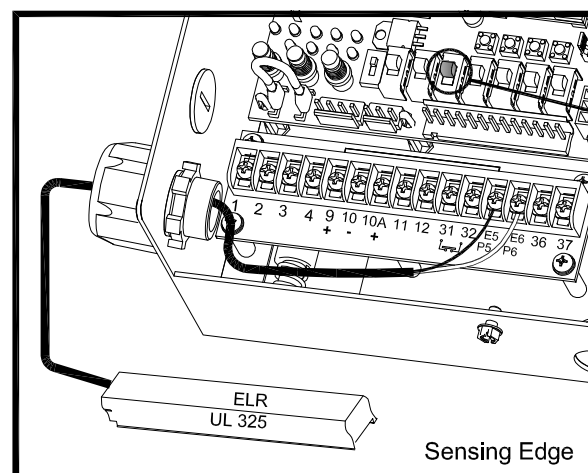

Photo Eyes



or



Sensing Edge

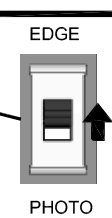

Step 10: Power ON

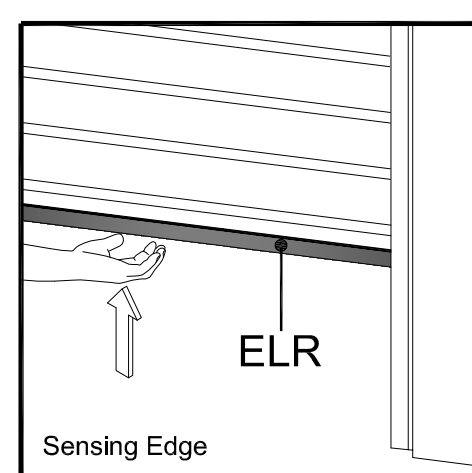
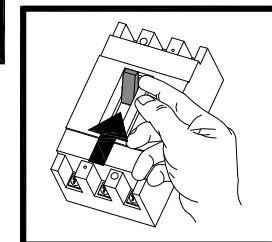

Sensing Edge

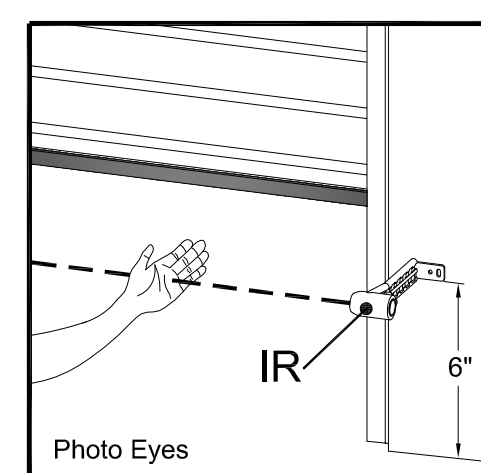

Photo Eyes

Step 9: Connect Primary Entrapment Protection Device If Provided

Step 11: Test 3-Button Control Station and Entrapment Protection Device

Not Included In the Box: Entrapment Device (Photo Eyes or Sensing Edge), Circuit Breaker, Cable Glands, or All Wires.

* Other Wirings or Installation Please See Installation Instructions

Quick Start (FS-EP) - 3 Phase

Warning: Disconnect Power Before Wiring.

QST-FS-EP-02-V01

Quick Start (FS-EP) - 3 Phase

Quick Start (FS-EP) - 3 Phase

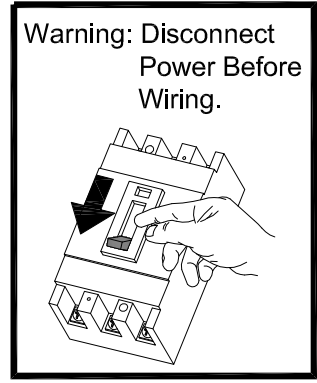
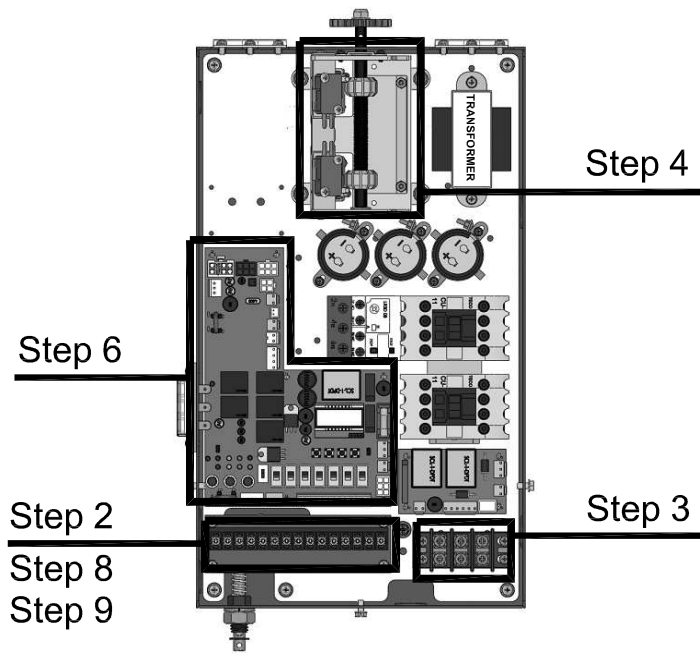

Step 1: Power OFF

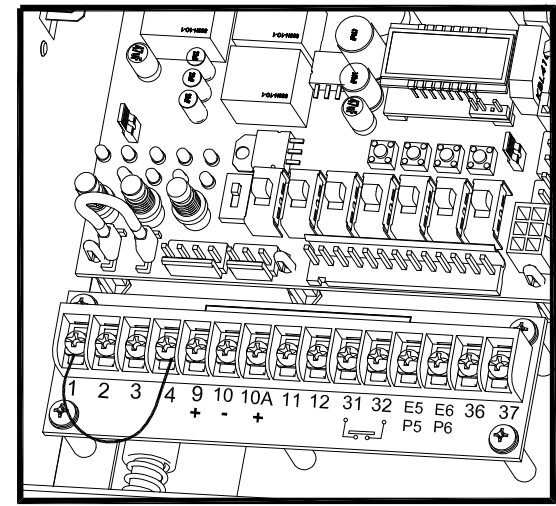

Step 2: Connect Wire 1 and 4 On CN2

For 208V input power, a wiring change is required - see wiring change instructions.

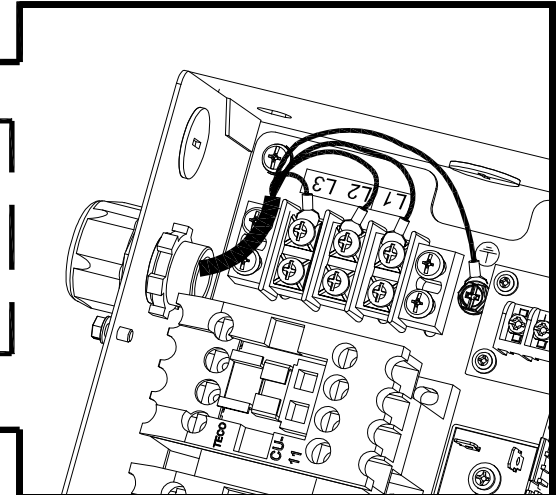

Step 3: Connect Line In

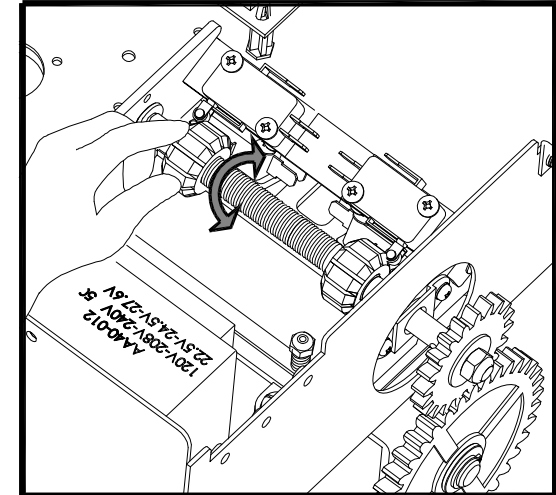

Step 4: Set Limits by Manually Running the Door. See installation instructions

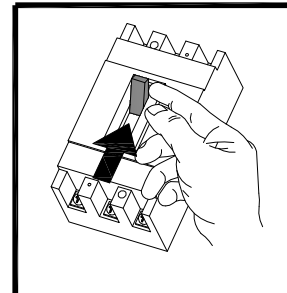

Step 5: Power ON

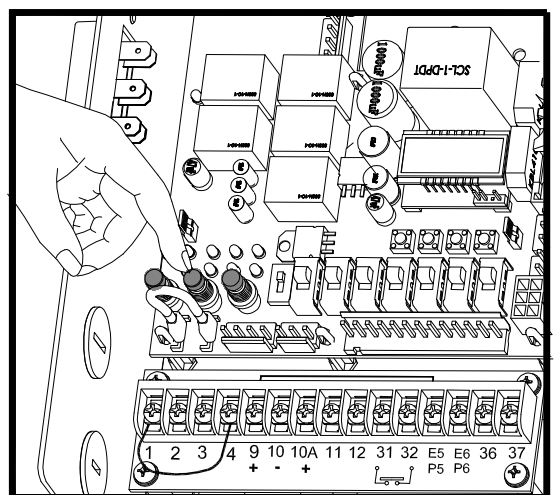

Step 6: Test Open, Close, Stop and Limits (Constant Pressure)

Note:
Door and Operator Must Function Properly Without External Connections.
Please call factory if you have problems.

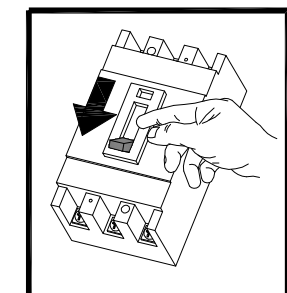

Step 7: Power OFF

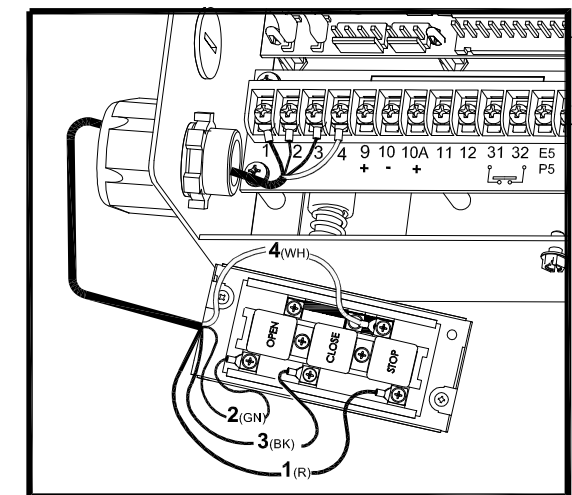

Step 8: Remove 1 and 4 Jumper, Connect 3-Button Station

Quick Start (FS-EP) - 3 Phase

Quick Start (FS-EP) - 3 Phase

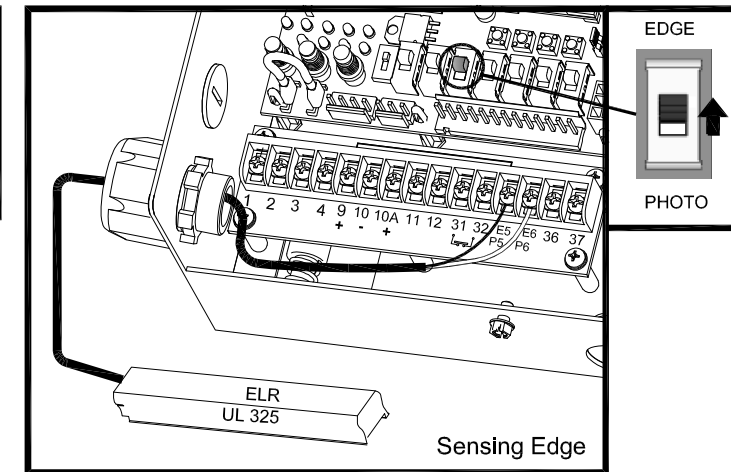
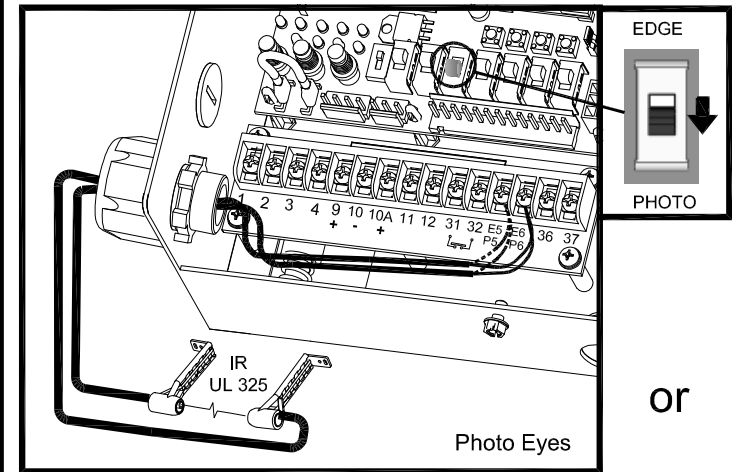

or

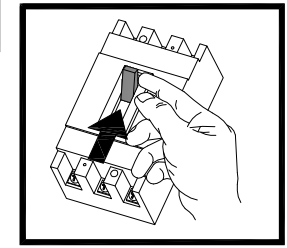

Step 10: Power ON

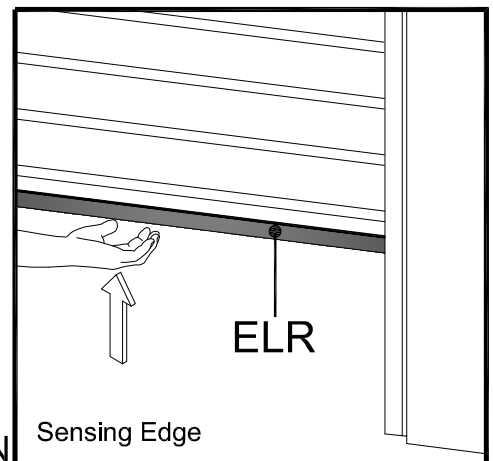

Sensing Edge

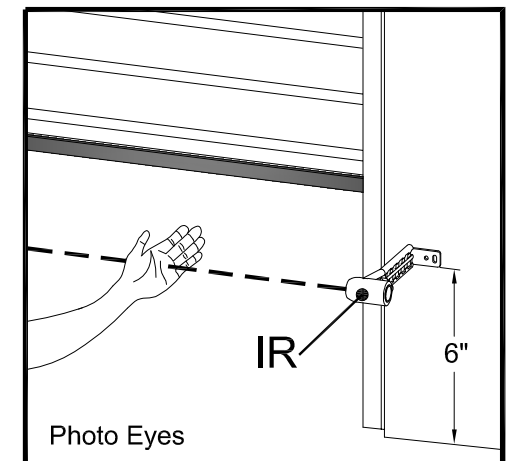

Photo Eyes

Step 9: Connect Primary Entrapment Protection Device If Provided

Step 11: Test 3-Button Control Station and Entrapment Protection Device

Not Included In the Box: Entrapment Device (Photo Eyes or Sensing Edge), Circuit Breaker, Cable Glands, or All Wires.

* Other Wirings or Installation Please See Installation Instructions