

Lawrence Quick Start (HGH EP) - 3 Phase

Warning: Disconnect Power Before Wiring.

QST-HGH-EP-02-(L)V01

Quick Start (HGH EP) - 3 Phase

Quick Start (HGH EP) - 3 Phase

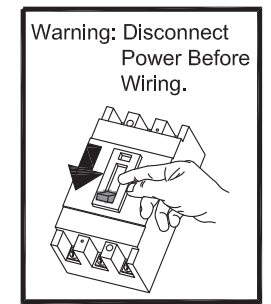
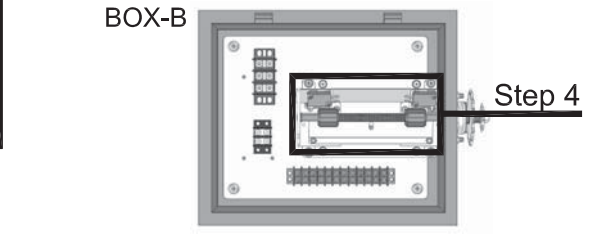
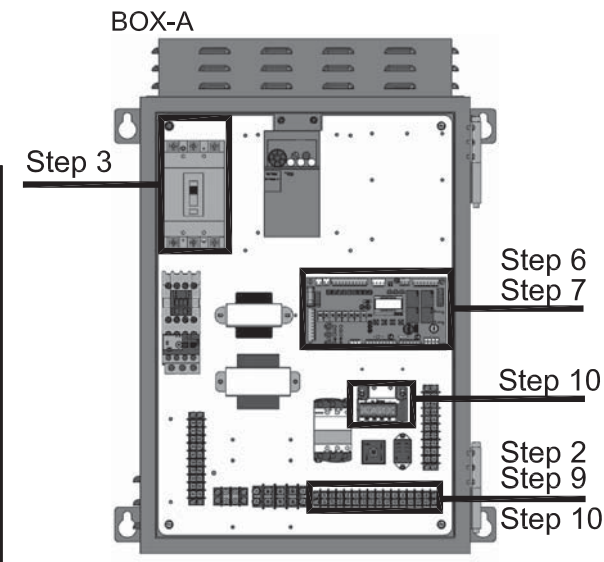

Step 1: Power OFF

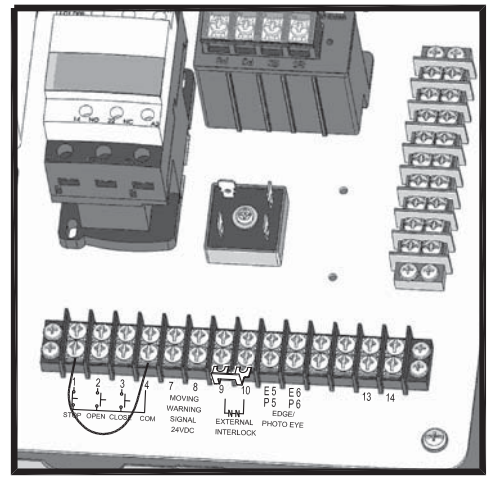

Step 2: Connect Wire 1 and 4 On TB5

For 208V input power, a wiring change is required - see wiring change instructions.

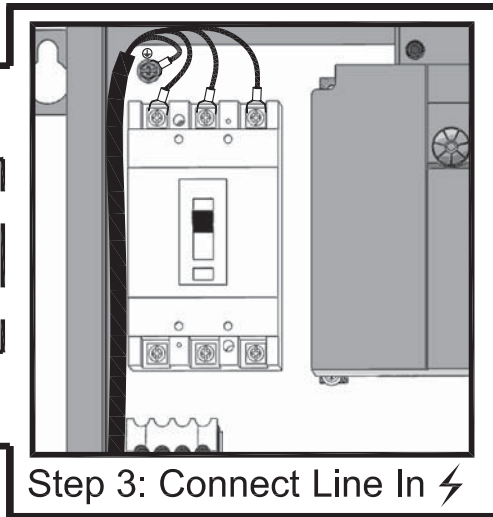

Step 3: Connect Line In ⚡

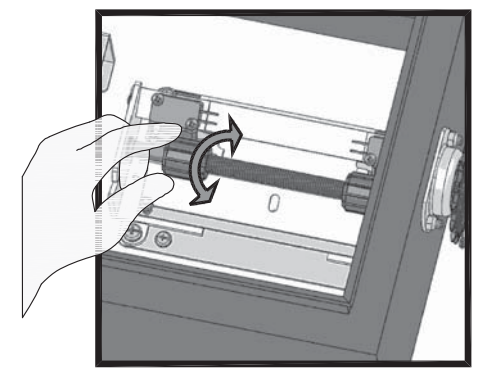

Step 4: Set Limits by Manually Running the Door. See Installation Instructions

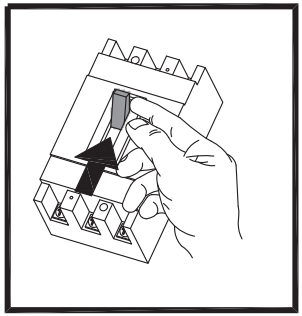

Step 5: Power ON

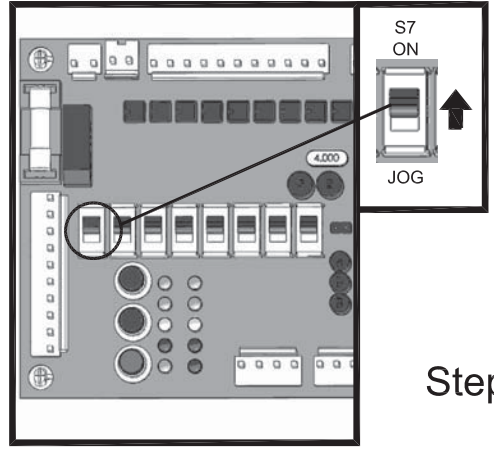

Step 6: JOG ON

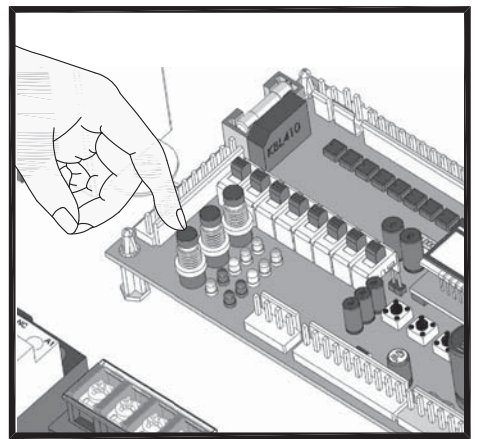

Step 7: Test Open, Close, Stop and Limits (Constant Pressure)

Note: Door and Operator Must Function Properly Without External Connections. Please call factory if you have problems.

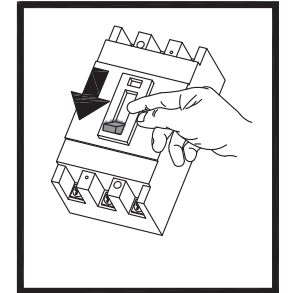

Step 8: Power OFF

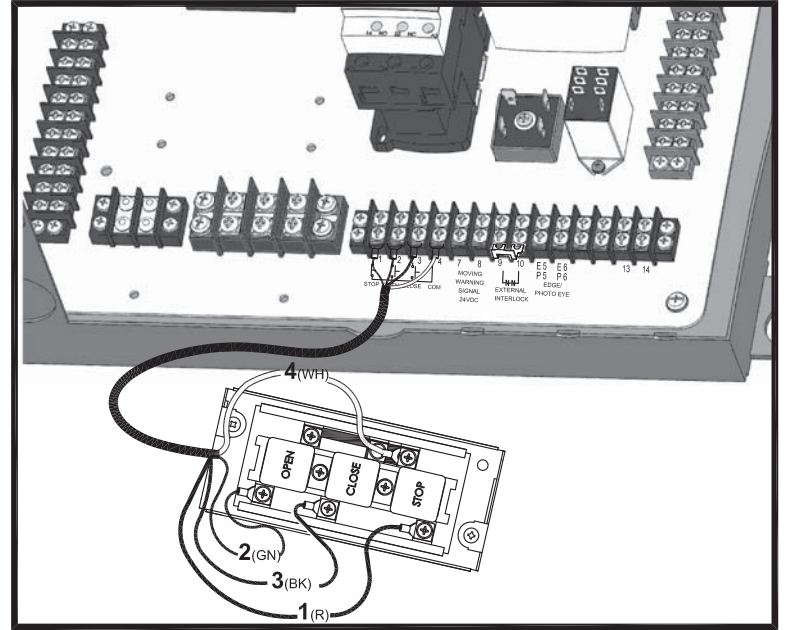

Step 9: Remove 1 and 4 Jumper, Connect 3-Button Station

Quick Start (HGH EP) - 3 Phase

Quick Start (HGH EP) - 3 Phase

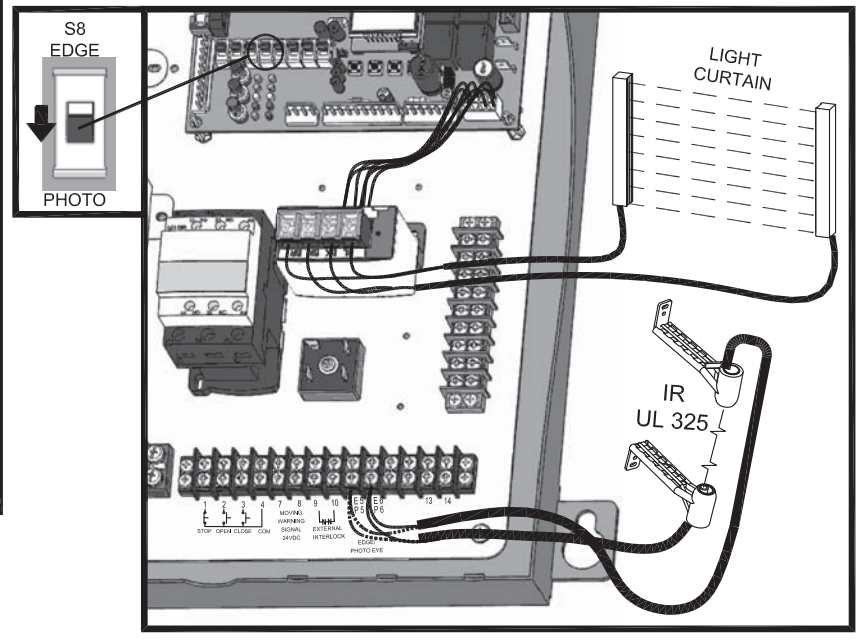

Step 10: Connect Primary Entrapment Protection Device (IR/ELR) And Telco Light Curtain As Above Illustrations If Provided.

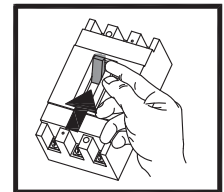
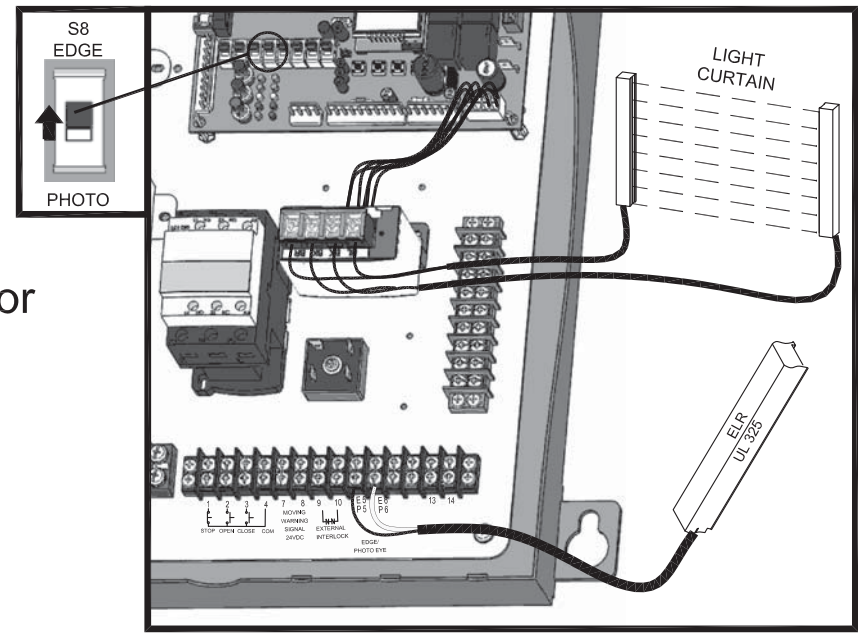

Step 11: Power ON

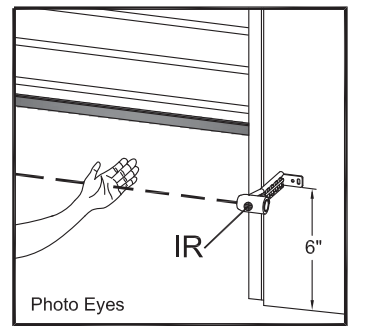
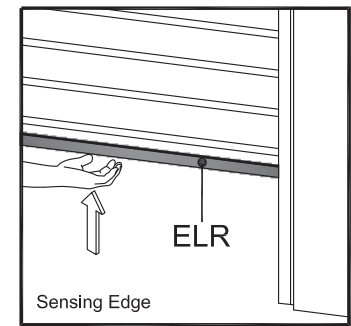

Step 12: Test 3-Button Control Station and Entrapment Protection Device

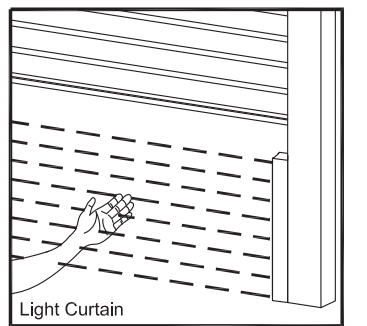

Not Included In the Box: Entrapment Device (Photo Eyes, Sensing Edge, Light Curtain), Circuit Breaker, Cable Glands, or All Wires.

* Other Wirings or Installation Please See Installation Instructions

Wiring Change Instruction from 230V to 208V 3 Phase Operator

HGH Series

HGH-3P-V03

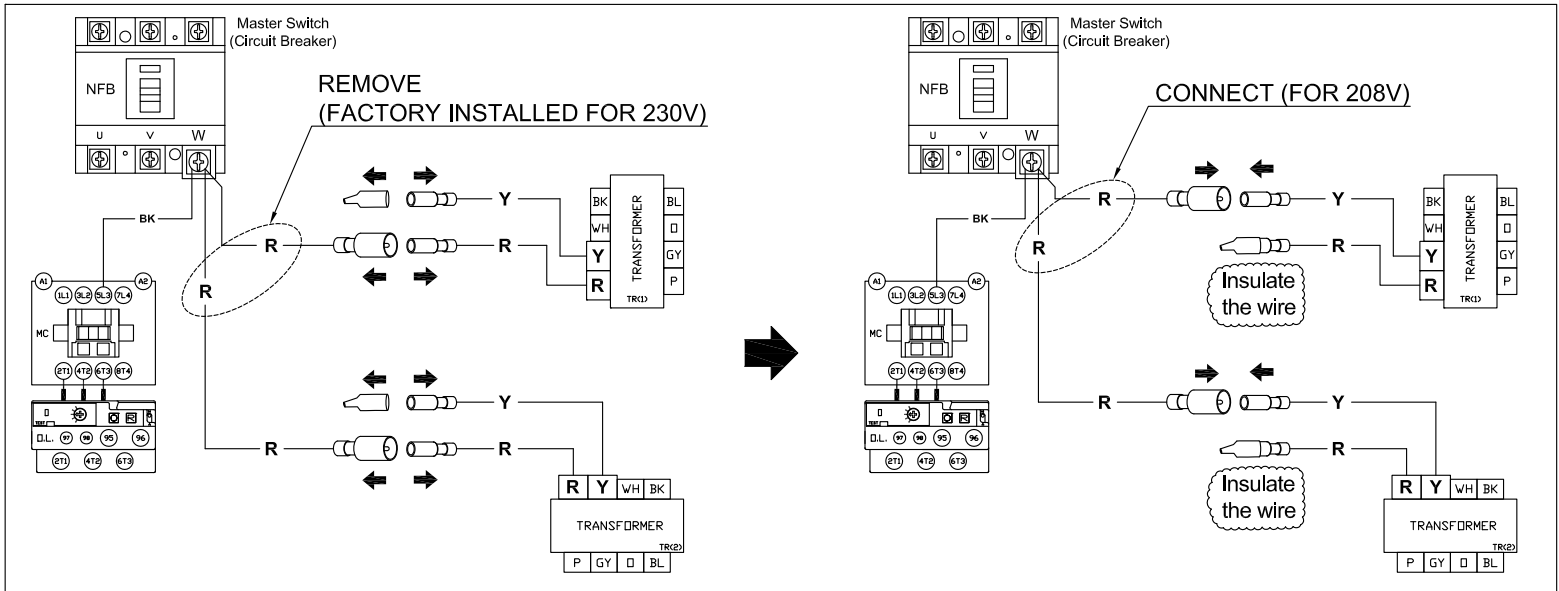

1. Unplug the red "230V" wire connector from the red "PWR" wire connector. Remove the insulating cap from the yellow "208V" wire connector.

2. Put the insulating cap on the red "230V" wire connector. Plug the yellow "208V" wire connector into the red "PWR" wire connector.

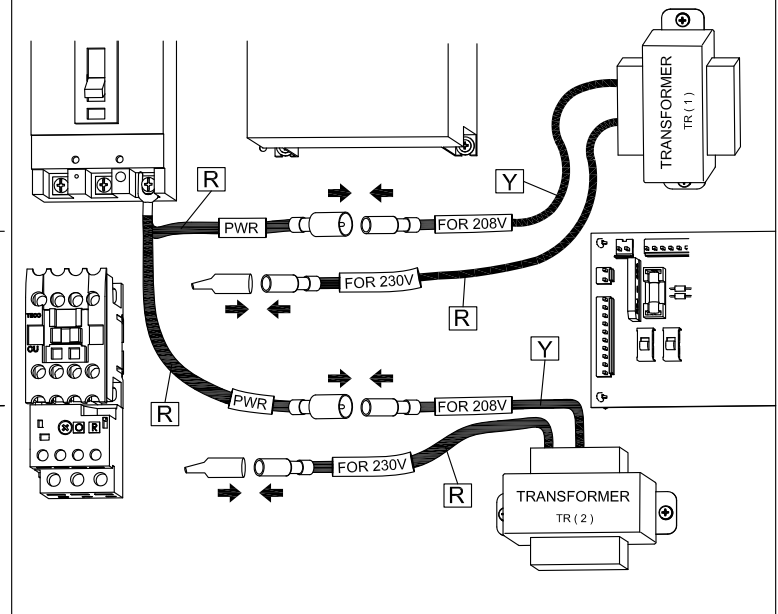
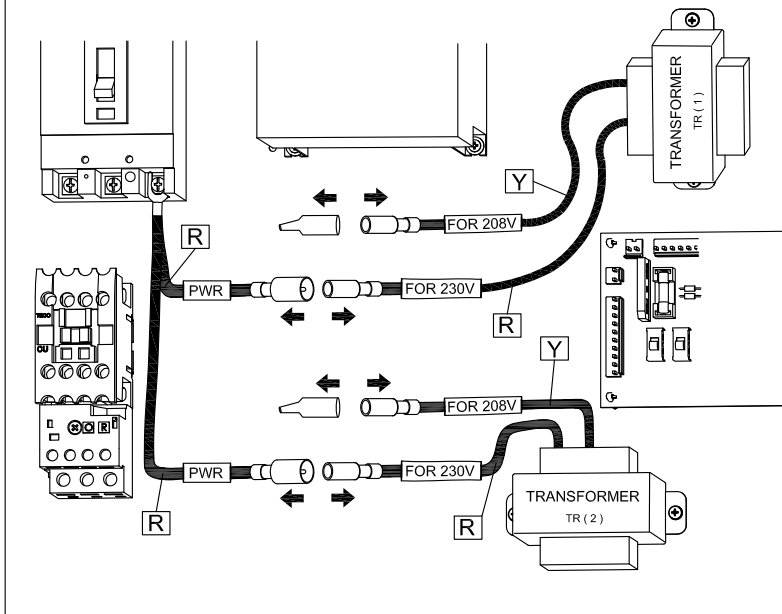

3. Completed.

