

MODEL DC

FOLDING GATES

Our Model DC Folding Gate is one of the most secure gates on the market, designed to provide maximum security and dependability.

FEATURES INCLUDE:

- Dual channel track construction for high security usage
- Portable version available
- Pivot option available
- Bi-parting design available

COMMON APPLICATIONS:

- Storefronts
- Jewelry/Liquor Stores
- Schools/Universities
- Pharmacies
- Government/Military



LAWRENCE
DOORS

SCAN
FOR MORE
INFORMATION



SPECIFICATIONS

MAXIMUM SIZE	17 ft. wide (single gate) or 34 ft. wide (bi-parting gate), 12 ft. high
GATE BODY	Vertical double 14 gauge steel channels spaced approximately 6" apart, with 3 double rows of 3/16" lattice bars between channels, riveted together though zinc plated steel washers
LEAD & REAR BARS LOCKING	14 gauge formed steel box channels Hasp suitable for padlocking gate in closed position (full height lock post on single gate), self-locking steel tie-back arm to hold gate in open position
BOTTOM ROLLERS	Machined steel ball bearing swivel double-wheel rollers in 14 gauge formed steel box channel bottom track with rubber floor pads
TOP GUIDE	Full height vertical double 14 gauge steel channels traveling though 14 gauge fomed steel box channel top track
FINISH	Factory applied black or gray paint
WARRANTY	Two year limited warranty (excluding finish)

COMMON OPTIONS

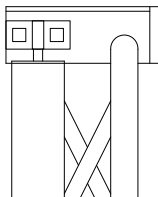

Pivot Gate

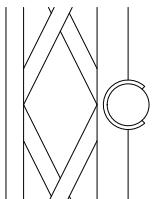

High security keyed pin lock

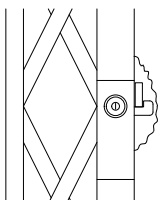

Cylinder locking device

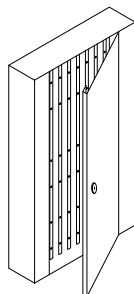

Gate cabinets - surface mount shallow cabinet shown, recessed or deep cabinet designs available

OTHER OPTIONS

- JC-1000 "Quick Release"
- Unequal Pair Gates
- Floating Gate Sections
- Portable Gates
- Powder Coat Finish

GATE DETAILS

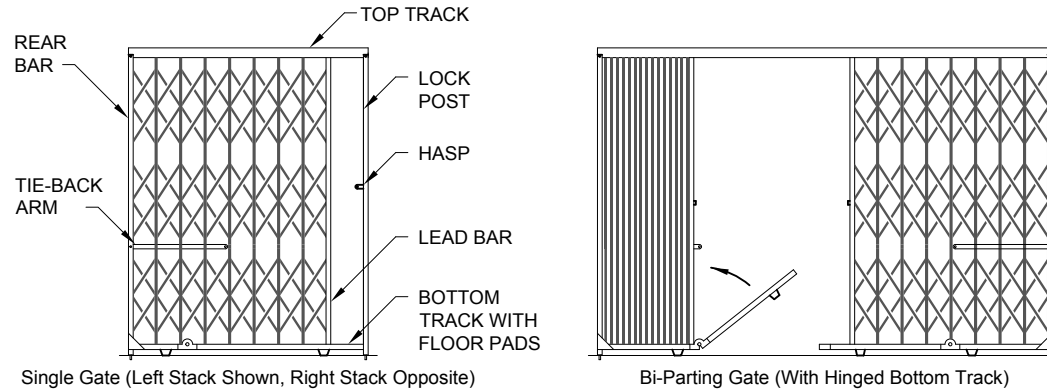

JAMB DETAILS

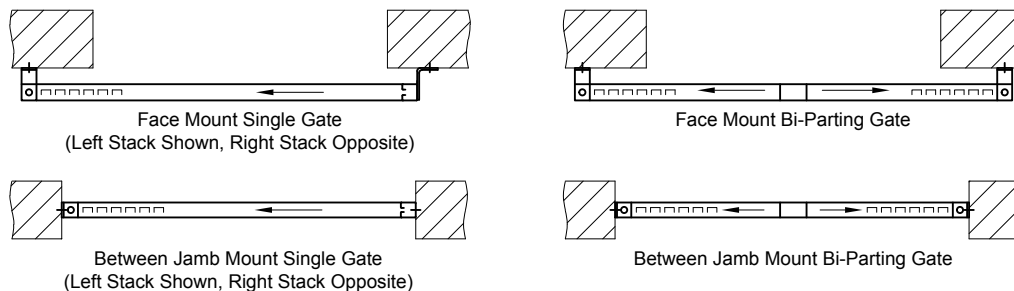

CLEARANCES:

Allow approximately 2" per ft. of gate width for stacking clearance.

HEAD DETAILS (Face mount details shown - between jamb mount similar)

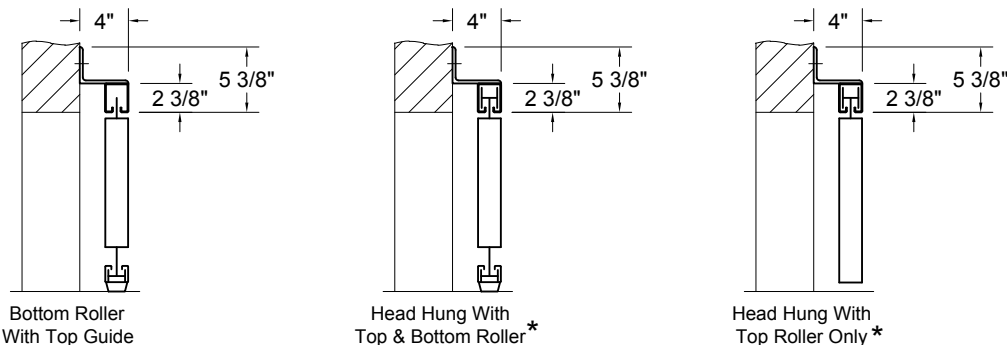

GENERAL NOTES:

Clearances are based upon standard gate construction. Some options may require additional clearance. Shop drawings for specific applications are available. Consult factory for any information not shown.

* Available as an option